

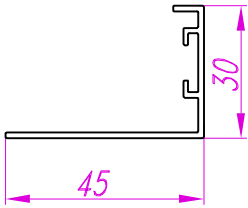

**ВЕНТИЛЯЦИЯ**

1

*НЧП-755, P-150*  
0.313/-



*НЧП-1828, P-280*  
3.9/-

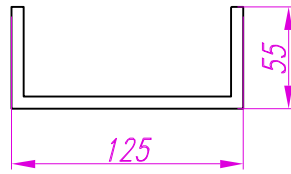

*НЧП-2336, P-150*  
0.210/-

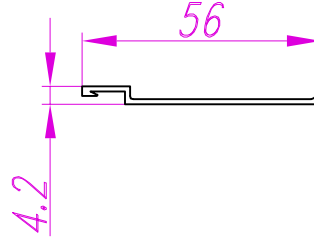

*НЧП-2337, P-146*  
0.115/-

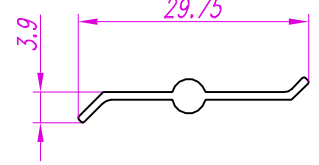

*НЧП-2338, P-146*  
0.123/-

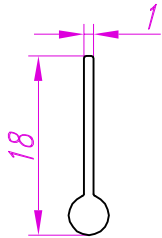

*НЧП-2339, P-150*  
0.248/-

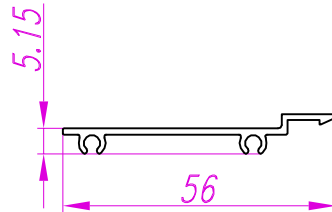

*НЧП-2342, P-150*  
0.194/-

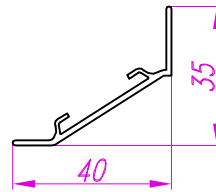

*НЧП-2344, P-188*  
1.917/-

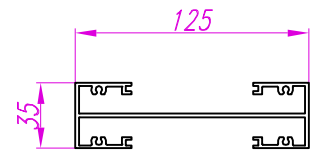

*НЧП-2345, P-150*  
1.574/-

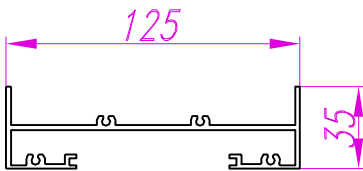

*НЧП-2346, P-188;150*  
0.991/-

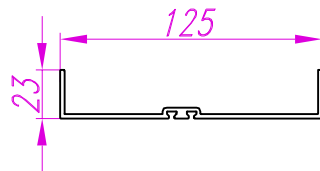

*НЧП-2347, P-188*  
1.651/-

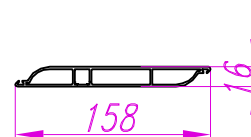

*НЧП-2348, P-188*  
1.137/-

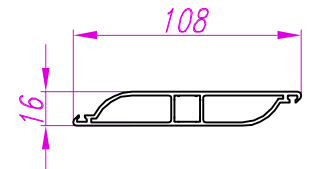

*НЧП-2510, P-188*  
1.718/-

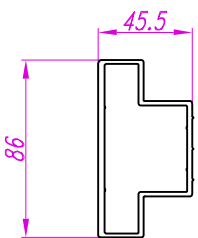

*НЧП-2511, P-188*  
1.633/-

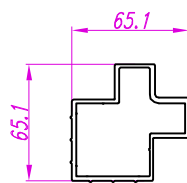

*НЧП-3072, P-146*  
0.188/-

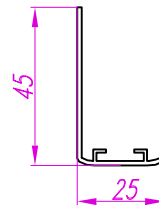

*НЧП-3073, P-150*  
0.442/-

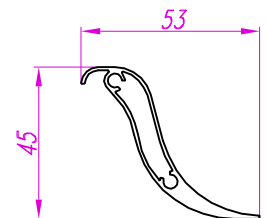

*НЧП-3736, P-150*  
0.722/-

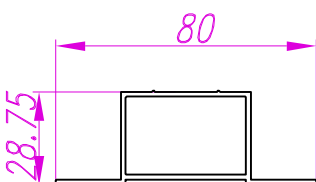

*НЧП-3737, P-280*  
1.864/-

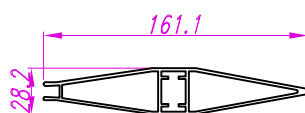

*НЧП-3738, P-146;150*  
0.746/-

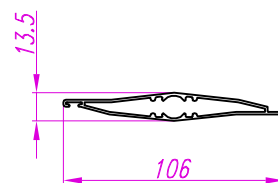

*НЧП-3874, P-146;188*  
0.618/-

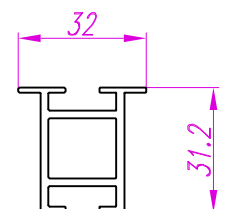

**ВЕНТИЛЯЦИЯ**

2

НЧП-4062, P-150  
0.284/-

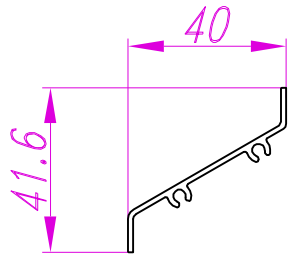

НЧП-4136, P-146  
0.294/-

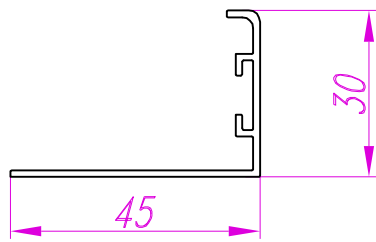

НЧП-4166, P-150  
0.405/-

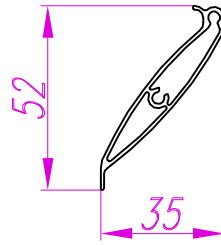

НЧП-4274, P-146  
0.443/-

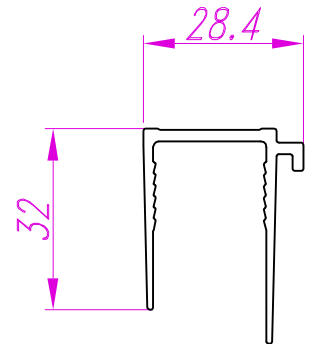

НЧП-4405, P-150  
0.900/-

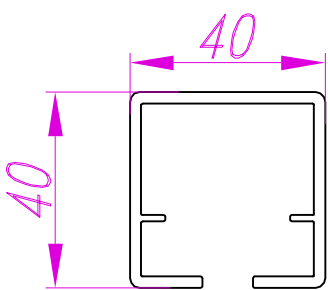

НЧП-4415, P-188  
0.852/-

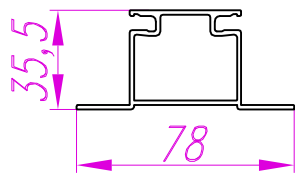

НЧП-4416, P-150  
0.919/-

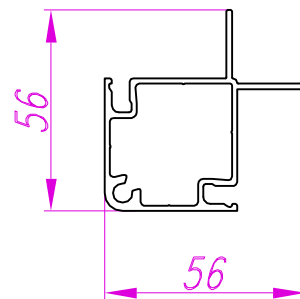

НЧП-4417, P-146  
0.126/-

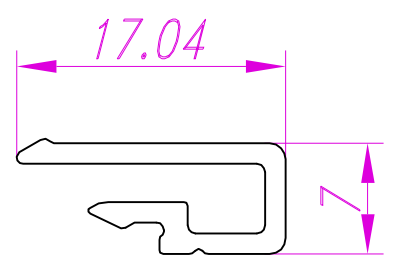

НЧП-4541, P-150  
0.305/-

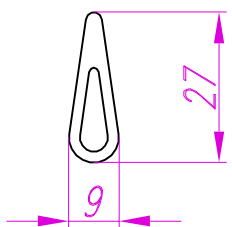

НЧП-5299, P-150  
0.112/-

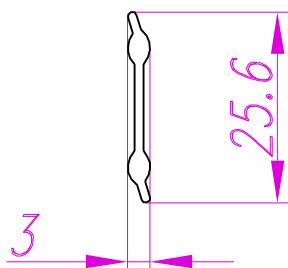

НЧП-5318, P-150  
0.159/-

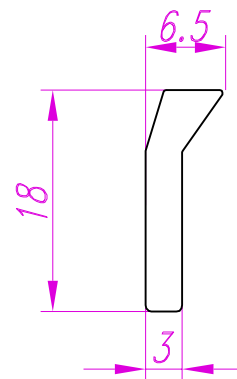

НЧП-5319, P-188  
0.138/-

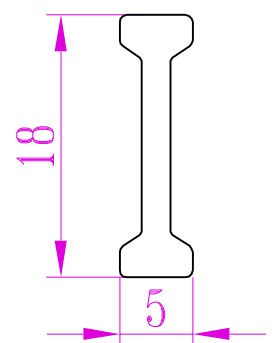

НЧП-5392, P-146  
0.187/-

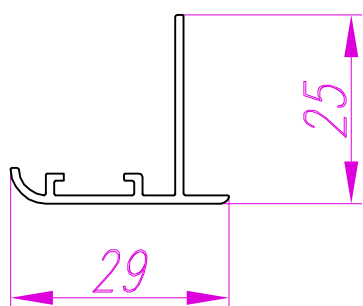

НЧП-5393, P-146  
0.322/-

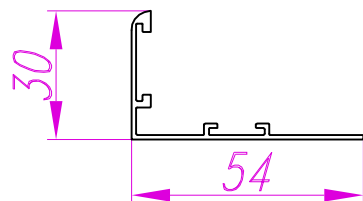

НЧП-5394, P-146  
0.175/-

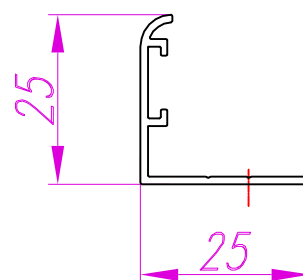

НЧП-5437, P-146  
0.299/-

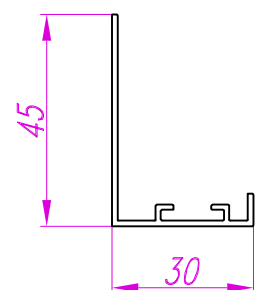

НЧП-5595, P-146  
0.996/-

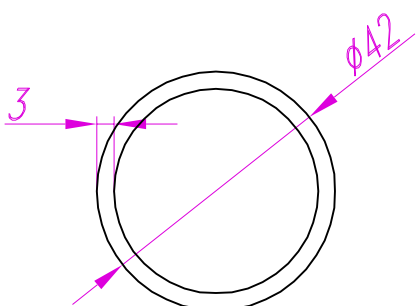

НЧП-5634, P-146  
0.242/-

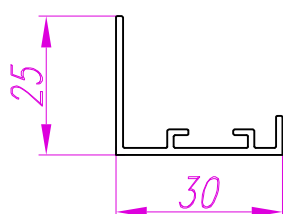

НЧП-5635, P-146  
0.109/-

